



Die Changing Consoles, electrically driven with push chain drive, die weight up to 50 tons



Advantages

- Lowest support heights possible
- High load and push force
- Easy insertion of the dies with push chain drive, semi- or fully automatic via roller or ball bars
- Precise positioning and approach of stops with rotary encoder possible
- Insertion of the die to the end position in the press
- Individual system with integration in the press control possible
- Flexible use at several presses
- Customised special solutions for a tailor-made changing system

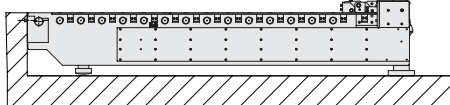
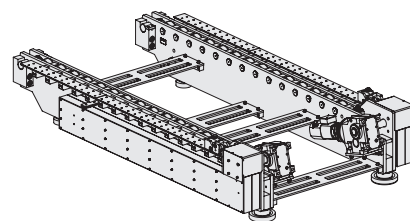

Console unit with low support height

Application

The push-chain console, designed based on standard die change consoles, is easy and space-saving to install and suitable for retrofitting and new installations.

Depending on the customer's individual requirements, different automation levels can be realised with integration into the press control.

Description

The main components of the die changing console are the manually movable carrying console and an electric push-chain drive.

This die changing console with special push-chain drive enables the user to change dies weighing up to 50 tons in hard-to-reach places, saving time and effort.

(Higher loads on request)

Roller and ball bars in the T-slots of the press bed allow easy handling when moving the dies. The carrying console can also be equipped with a hydraulic lifting column with a foot lever for easy docking into the hooks as an option. Steering rollers allow easy transport of the complete system from one installation to the next.

Tandem die changes are also possible to optimise set-up times.

Dimensioning and further technical details in the course of the project

Please contact us!

Function

The drive unit and carrying console are hung in hooks manually on the die-changing side of the press and locked in place; no further machining of the machine table is necessary for use.

The die is placed on the consoles using a crane or a forklift truck.

Depending on the customer's requirements, the die is coupled to the push chain of the changing unit with a customised die adapter.

The integrated chain drive system allows the user to automatically load and position the die by pressing a push-button on a separate remote control. Sensors and stops can be integrated into the control system.

During a die change, the press bed is free, i.e. the push and pull elements do not project over the press bed. Also, the rear side of the press is completely free. This changing unit is suitable for almost any press, can be easily removed and is easy to handle.



View of pull-push chain and die adapter



Optional: The control is directly mounted to the console; console and control can be completely removed.

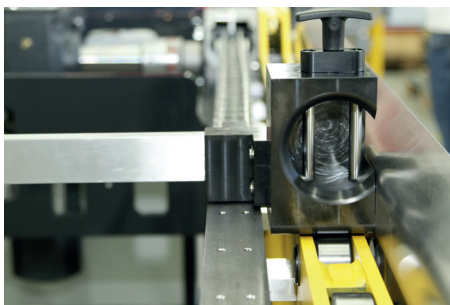

Push-pull docking device, customised

Push Chain
Variants • Application examples

Push chain direct system

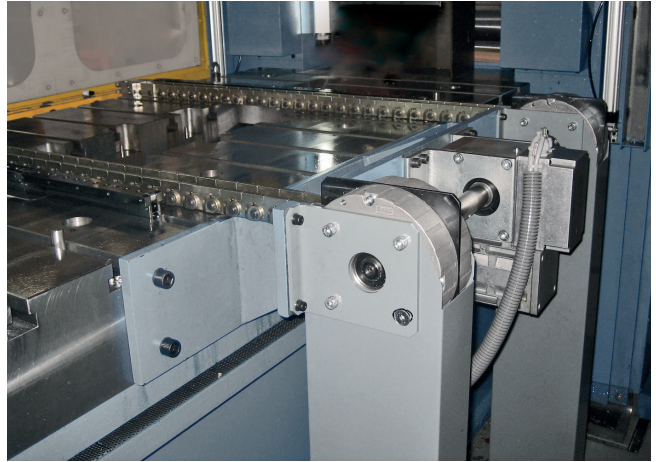
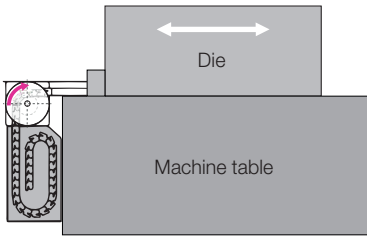

Console with driven pull-push chain

Push chain – direct system with console

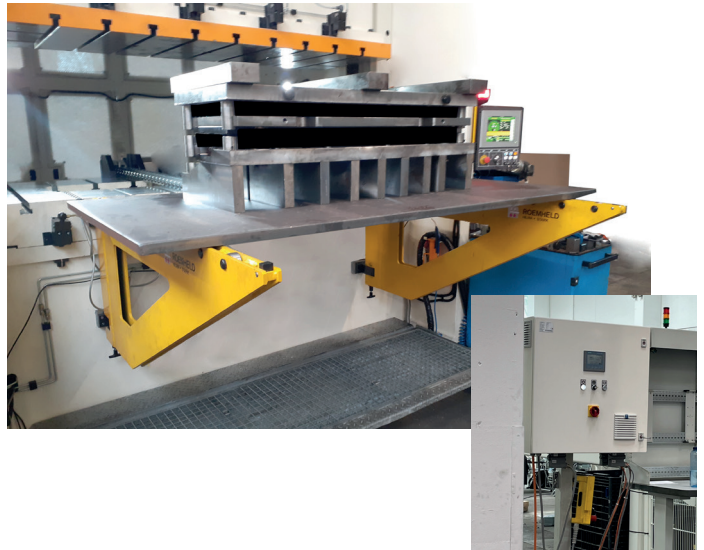
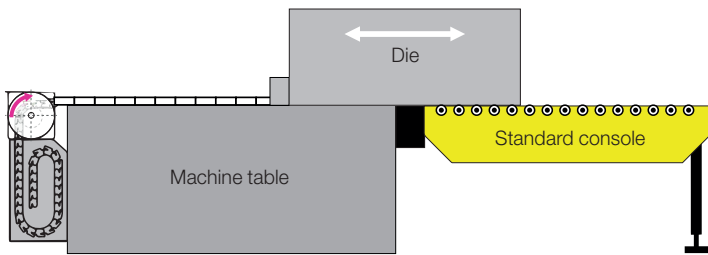

Push chain console

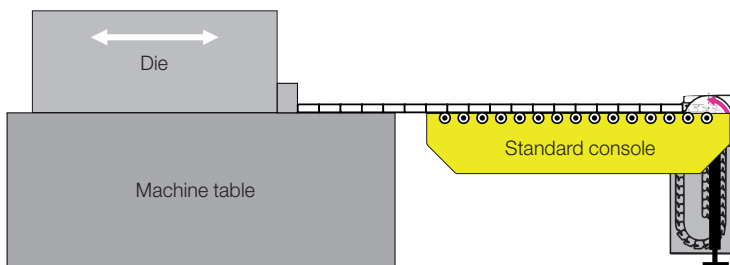

Console with pull-push chain

Push-pull Docking Device Versions Chain Guide

Version without push-pull docking device

In this version, the unit is supplied with a front-end link. This allows for the adaptation of existing or self-designed push-pull docking devices.

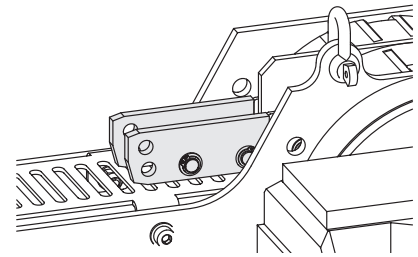

Push-pull docking device with semi-automatic connection

The die is connected automatically and loosened manually.

A suitable die adapter for each push-pull docking device is included in our delivery

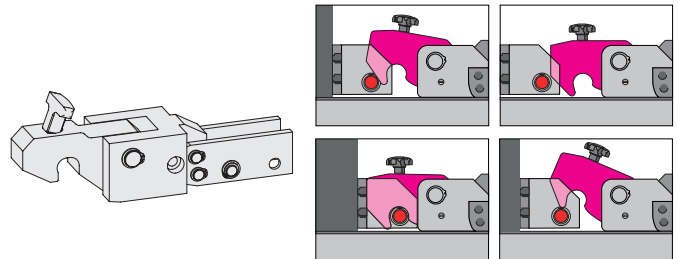

Push-pull docking device, 2 pcs with safety bolts

For connecting the push-pull docking device and push-pull docking device block (bolted to the die)

The connection is secured by a locking bolt and can be removed manually when in neutral position. Equipped with push-pull docking device and push-pull docking device block.

A suitable die adapter for each push-pull docking device is included in our delivery

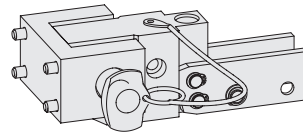

Push-pull docking device with screw-on plate

This version facilitates a permanent connection between the push chain direct system and the base plate.

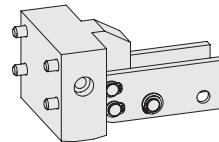

Fully automatic push-pull docking device

Connecting the dies to the push chain direct system is handled entirely by the control. Pneumatic or electric cylinders are used to activate the push-pull docking device when a predefined distance to the die is reached, enabling fully automated tool changes.

A suitable die adapter for each push-pull docking device is included in our delivery

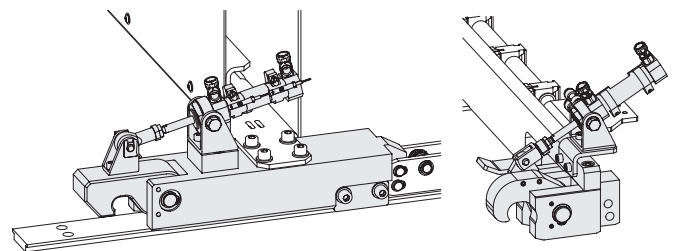

Chain guide

A chain guide is necessary to realise long chain strokes and to prevent a lateral break-out of the push chain.

Avoid side loads acting on the push chain.

The maximum force of the pull-push chain is possible with a guide also over longer distances.

The sliding surface of the push chain must be at table level. The length to which a push chain can be loaded without a guide depends on the factor of friction, the die weight and the push length.

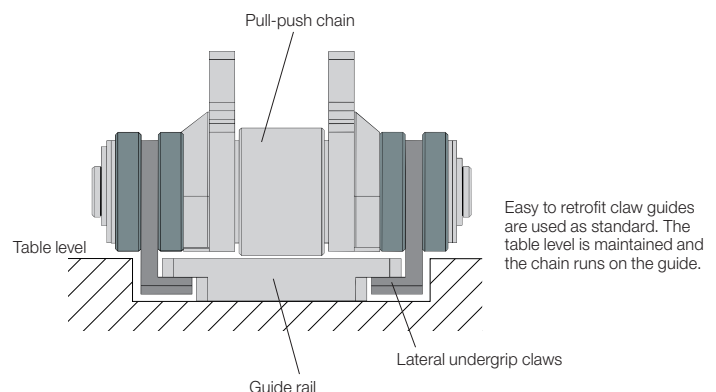

Electric Controls Versions

Electric controls for use on driven die changing systems

Driven die changing systems can be controlled by the customer using an existing machine control or a standard control from Römheld. We offer a ready for connection plug & play system that has been specially designed for controlling the driven carrying console or pull-push chain.

For optimum operation of the driven die changing systems, we recommend the following minimum requirements for control:

- Integration in the press emergency stop
- Position monitoring: front and rear end position of the drive units
- Wired remote control, soft start, deceleration ramp and overload protection
- Two speeds: Normal speed & creep speed

Depending on the degree of automation, we offer three different electric controls with corresponding operating units:

Basic control	Required specifications
Input voltage flexible 400–480 V, 50/60 Hz, 3~ three-phase current	
Voltage supply and signal exchange to the terminal strip (cable not included in delivery) For controlling 1 or 2 three-phase motors up to max. 1.5 kW	
Connecting cable “control - drive unit” up to 10 m cable (1 cable per drive motor) permanently wired to the control and the drive unit, insertable (Harting connector)	Length (2–10 m): <input type="text"/> m
End position control via inductive proximity switches	
Standard remote control with 5 m cable, permanently connected to the control, without end position indicator light	
Soft start, deceleration ramp and overload protection via speed starter (fixed setting)	
Standard components for motors: KEB, speed starter: Phoenix, control box: Rittal (600 × 600 × 250 mm), UL-conform components	
Safety Collective signal input “Release of press”, emergency stop for press, two-channel (PL “D”)	

Possible options for Basic control	
Creep speed Additional switch on remote control for creep speed, 20 %	<input type="radio"/> With creep speed

Electric Controls Versions

Advanced control like Basic, additionally with

Connecting cable for power supply, 10 m, with open cable end, permanently connected to the control

Connecting cable for signal exchange with the press, 10 m, with open cable end, permanently connected to the control unit

Connecting cable “control - drive unit” up to 10 m cable (1 cable per drive motor)

connected to the control, insertable, and the drive unit, insertable (Harting connector)

Length (2 – 10 m): m

Standard remote control with 5 m cable, connected to the control, insertable (Harting connector), with end position indicator light

Built-in PLC control module (Beckhoff) for an optional remote maintenance module and provision of the following contacts:

- Signal to external “End position at the rear” (= drive/die completely out of the press in end position)
- Additional emergency stop signal contact

Standard components Beckhoff control module, KEB motors, Phoenix speed starter, Rittal control box 600 × 600 × 250 mm), UL-compliant components

Safety Collective signal input “Release of press”, emergency stop for press, two-channel (PL “D”)

Possible options for Advanced control

Safety remote control

Sturdy housing, with panic buttons and dead man's switch (two-hand operation), connecting cable 5 m, connected to the control, insertable (Harting connector)

With safety remote control

Creep speed

Additional switch on remote control for creep speed, 20 %

With creep speed

Remote maintenance unit in the switch cabinet.

Ethernet connection or via mobile radio (SIM card not included)

With remote maintenance unit

Advanced Plus control like Advanced, with additional options:

Radio remote control

With radio remote control

Display package: 3.5" display panel on the control box with text display of function and fault signals, programming of stopping points in conjunction with absolute rotary encoders on each drive

With display package

Signal exchange package: Available individually on terminal strip

- Release signal 1 (e.g. “roller bars lifted”)
- Release signal 2 (e.g. “press/ram in top dead centre”)
- Release signal 3 (e.g. ...)
- Ext. signal “Die position 1” (from here onwards, retracting speed at creep speed 20 %)
- Ext. signal “Die position 2” (STOP retraction movement, end position in the press reached)

With signal exchange package

Control unit

Control box: Rittal (600×600×250 mm)



Standard remote control



Safety remote control

Sturdy housing, with panic buttons and dead man's switch (two-hand operation)



Display package

3.5" panel on control box



Sketch of Installation Situation

