

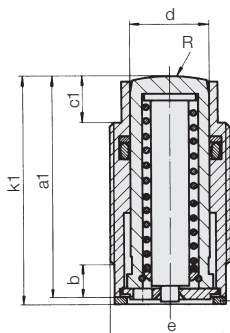

Threaded-Body Cylinder
single acting with spring return
max. operating pressure 500 bar



Version without female thread



Version with female thread

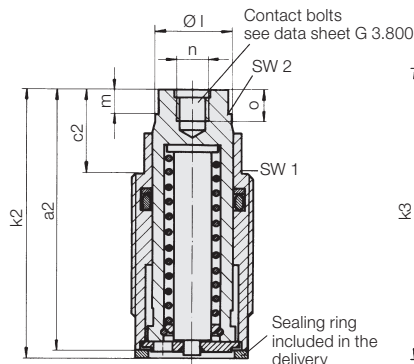

Version with swivel contact bolt

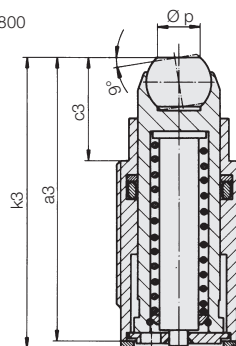

Description

These threaded-body cylinders can be threaded directly into tapped holes in the fixture down to the hex-section of the cylinder body. Spacings between cylinders can be minimised when cylinders are arranged in a row, since the oil is fed through drilled passages in the fixture. Sealing is made with the supplied sealing ring at the bottom of the location hole.

A long piston guide in combination with an O-ring/back-ring seal provides trouble-free operation.

Material

Piston material: casehardening steel, hardened
Cylinder body: free-cutting steel

Important notes

Threaded-body cylinders must not be subjected to a load in retracted position.

Cylinders have to be protected against direct influences of aggressive cutting lubricants and coolants.

A version with very little leakage equipped with a double-wiper, that has the same technical data, can be found on data sheet B 1.461.

Operating conditions, tolerances and other data see data sheet A 0.100.

Accessories and application examples

see reverse page

Piston Ø d	[mm]	12	16	20	25	32
Stroke	[mm]	10	12	15	16	20
Clamping force at	100 bar	[kN]	1.1	2.0	3.1	4.9
	500 bar	[kN]	5.7	10.1	15.7	24.6
Spring return force. min.	[N]	28	50	78	123	200
Min. operating pressure	[bar]	10	10	10	10	10
Oil volume per 10 mm stroke	[cm ³]	1.13	2.01	3.14	4.91	8.04
a1	[mm]	37	45.5	55	58	85
a2	[mm]	44	51.5	64.5	67	96
a3	[mm]	44.5	53	68.5	71	98
b	[mm]	7	8	8	11	12
c1	[mm]	7	10	11	13.5	17
c2	[mm]	14	16	20.5	22.5	28
c3	[mm]	14.5	17.5	24.5	26.5	30
Ø d	[mm]	12	16	20	25	32
e	[mm]	M22x1.5	M26x1.5	M30x1.5	M38x1.5	M48x1.5
f min./max.	[mm]	16 / 31	20/36	24/45	28/46	42/70
g max.	[mm]	8	9	9	11	13
Ø h min./max.	[mm]	9/12	12/16	14/20	18/25	22/32
i min.	[mm]	25	30	35	43	55
k1	[mm]	38	46.5	56	59.5	87
k2	[mm]	45	52.5	65.5	68.5	98
k3	[mm]	45.5	54	69.5	72.5	100
Ø l	[mm]	11	15	19	23	30
m	[mm]	5.5	5.5	6	7	9
n	[mm]	M6	M6	M8	M8	M12
o	[mm]	6	6	8	8	12
Ø p	[mm]	7.2	7.2	10.5	10.5	20.0
R	[mm]	20	25	32	40	50
SW 1	[mm]	17	22	24	32	41
SW 2	[mm]	10	13	17	19	24
Seating torque	[Nm]	40	50	60	80	225
Weight	[kg]	0.08	0.15	0.22	0.38	0.97
Version without female thread		1460000	1461000	1462000	1463000	1464000
Version with female thread		1460001	1461001	1462001	1463001	1464001
Version with swivel contact bolt		1460010	1461010	1462010	1463010	1464010
Additional seal		3000840	3000841	3000842	3000843	3000527

Porting details

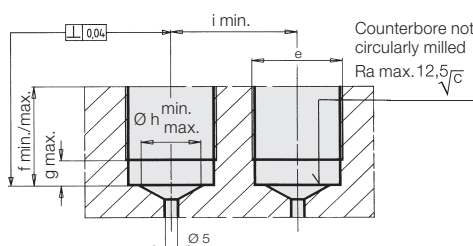

Accessories

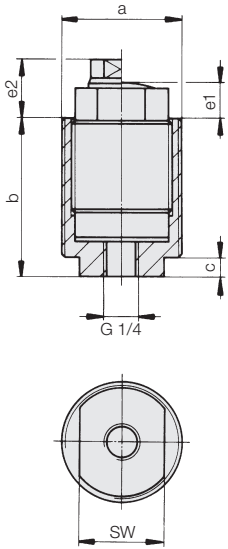

Mounting bodies

The installation of threaded-body cylinders directly into fixture base plates and walls becomes possible by means of mounting bodies, which are provided with porting for threaded fitting connections.

For cylinder no.	14600XX	14610XX	14620XX	14630XX	14640XX
a	M28x1.5	M32x1.5	M38x1.5	M45x1.5	M60x1.5
b	44	49	58	59	85
c	7	7	7	7	8
e1	7	10	11	13.5	17
e2	14	16.5	20.5	22.5	28
SW	22	24	27	32	41
Weight [kg]	0.1	0.12	0.23	0.28	0.8
Part no.	3467084	3467085	3467086	3467087	3467093
Lock nut DIN 1804	M28x1.5	M32x1.5	M38x1.5	M45x1.5	M60x1.5
Part no.	3301423	3301019	3300088	3300326	3300411

Application examples

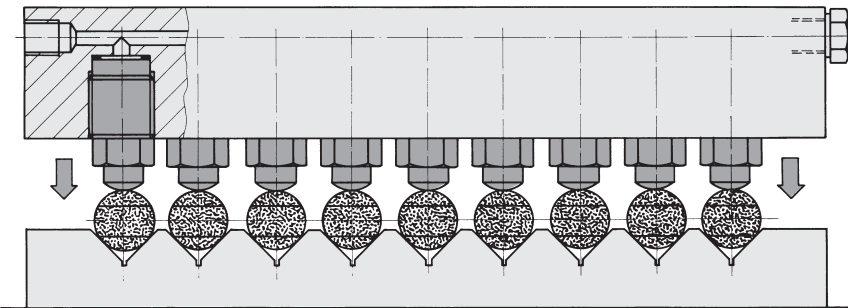

The opposite figure shows a multiple clamping fixture for clamping of small parts. The cylinders can be arranged in a clamping bar or yoke.

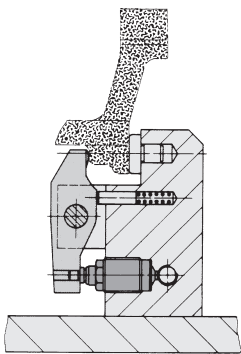

Workholding with the use of reversing levers is particularly suited for workpieces which have to be clamped high above the fixture base plate. The force-loop closed within a limited fixture component space eliminates bending forces from entering the fixture base plate. The reversing lever allows easy adaptation of the lever ratio to the clamping force required.

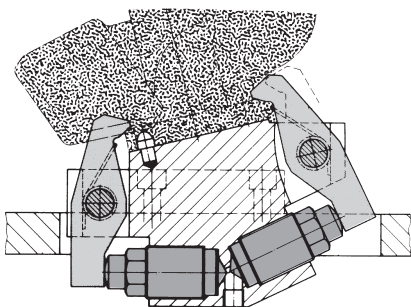

This example shows a detail of a clamping fixture for exhaust manifolds, where under limited space conditions the use of reversing levers allows clamping of workpieces with intricate contours.

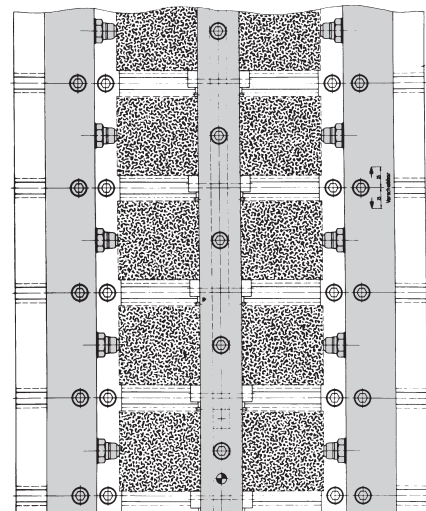
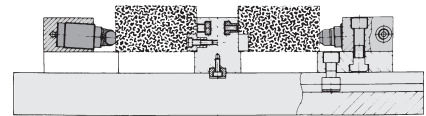

The above multiple clamping fixture is equipped with threaded-body cylinders with swivel contact bolts. The 3° incline of the threaded-body cylinders effects a low-clamping force of approx. 5% of the clamping force. On plane clamping surfaces swivel contact bolts obtain little surface pressure on the effective points.