



**Arch Clamps for Flat Clamping Edge**  
double acting, clamping force 30 to 450 kN,  
with mechanical lock, without and with position monitoring at the side



**Advantages**

- Extremely sturdy and process-safe
- Easy to unclamp even after the hardest use
- Integrated lock secures the upper die or mould in the case of pressure loss
- High operational safety by position monitoring and automatic motion sequence
- High sliding properties and corrosion resistance due to special coating process

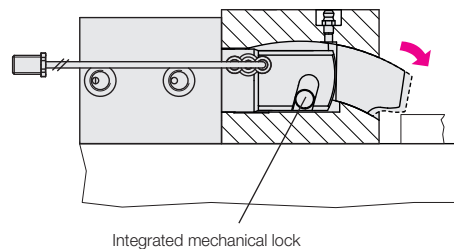

**Application**

Double-acting arch clamp with integrated locking bolt for clamping dies or moulds on a press bed and ram in machines and systems, such as die casting and injection moulding machines.

**Description**

The arch clamp consists of a hydraulic block cylinder and a piston guided in a housing. The arch-shaped clamping bolt clamps the die or mould by placing on the flat clamping edge. Due to the design inside the clamping element, the horizontally-acting force is deflected and hits the clamping surface almost vertically.

**Retrofitting to arch clamping**

Retrofitting existing moulds/dies to arch clamping is possible by using the pressure bars shown below. Max. hardness 60 HRC

**A high level of safety**

The arch clamp has a mechanical lock which holds the clamping bolt in its clamping position in the case of a pressure drop. The upper die or mould is thus secured against falling down.

**Important notes**

In case of incorrect operation of the arch clamps, the clamping bolt may fully retract into the guide housing and thus cause the upper mould/die falling off the ram.

The greasing intervals (high temperature grease) should be adapted to the existing operating conditions. Please note that greasing of the clamping bolt should only be made with the elements being retracted.

The clamping elements must be protected against dirt, scale, swarf, coolant, etc. by means of a suitable covering.

Moulds or dies clamped by means of arch clamps on the press ram, it is recommended that multiple-circuit hydraulic supply of the clamping elements and pilot-controlled check valves are used for securing hydraulic clamping.

**Versions**

- without position monitoring  
max. temperature: 160 °C (250 °C on request)
- with position monitoring at the side  
max. temperature: 100 °C

**Position monitoring**

The integrated position monitoring is coupled to the clamping bolt in a very space-saving way at the side and signals:

1. Clamping bolt in unclamping position
2. Clamping bolt in clamping position
3. Error message when overrunning the clamping position

**Clamping force**

This is the force the clamping element applies to the mould or die. The mould or die is clamped on the fixture plate by means of this force. The external forces acting on mould or die (e.g. ejecting force or die cushion force) shall not exceed the totality of the elements' clamping force.

**Maximum admissible process force**

The process force is the max. admissible pressure in the block cylinder. During operation, a compressive force is exerted on the oil cushion in chamber A. As a result, the pressure in the block cylinder exceeds the clamping pressure. This means that the pressure relief valve/safety valve, that limits the pressure in the clamping element, must be adjusted to the process pressure. If the pressure in chamber A rises above the specified process pressure, the pressure relief valve/safety valve should release the excess pressure.

**Circuit diagram**

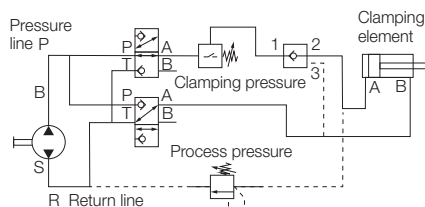

For safety reasons and in the sense of the machine tool guide lines ML2006/42/ EC the hydraulic pressure must be maintained. When upper moulds/dies are clamped by arch clamps, they must be secured mechanically when maintenance work is carried out.

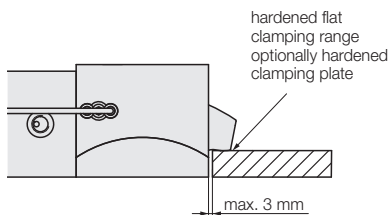

# Arch clamps without position monitoring, with mechanical lock

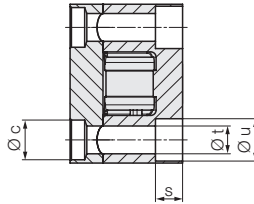
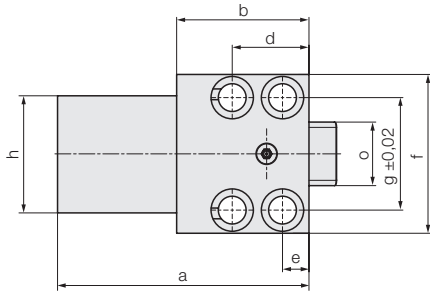
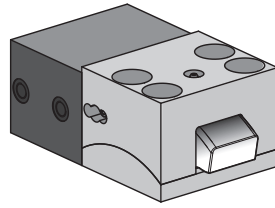
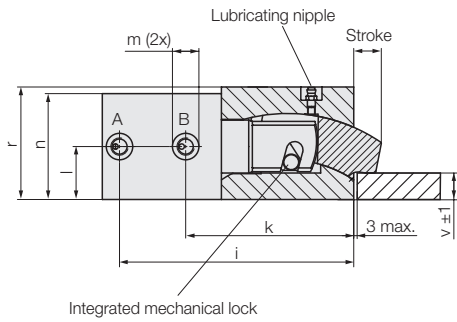

### Installation of drill bushings to absorb side loads

Drill bushings for the absorption of side loads must be inserted in the support surface!

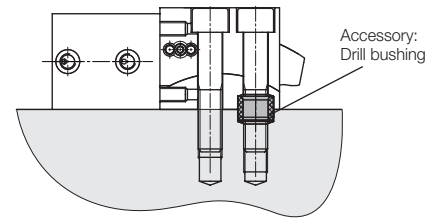

### Technical data

Temperature resistance up to 160 °C

Max. clamping force	[kN]	30*	50**	80	125	200	310	450
Max. admissible process force	[kN]	45	65	110	175	275	430	620
Max. clamping pressure	[bar]	200	200	200	200	200	200	200
Max. unclamping pressure	[bar]	200	200	200	200	200	200	200
Max. process pressure	[bar]	250	250	275	275	275	275	275
Cylinder Ø	[mm]	40	50	63	80	100	125	150
Max. stroke	[mm]	15	20	25	25	25	30	38
Max. oil consumption	[cm <sup>3</sup> ]	10	31	90.4	188	384	314	918
a	[mm]	133	161	190	239	290	325	395
b	[mm]	70	84	100	140	160	180	220
Ø c H7 x depth	[mm]	18/7	26/9	30/11	35/11	48/13	55/16	62/16
d	[mm]	37.5	46	58	75	78	95	108
e	[mm]	12.5	16	20	25	26	32	38
f	[mm]	80	98	120	150	198	240	280
g	[mm]	55	65	85	106	140	180	210
h	[mm]	80	98	120	130	160	200	255
i	[mm]	111	146	177	220	270	285	370
k	[mm]	76	102	127	170	195	215	280
m		G 1/4	G 1/4	G 1/4	G 1/2	G 1/2	G 1/2	G 1/2
n	[mm]	56	66	80	100	130	160	195
o	[mm]	32	38	48	55	75	100	120
r	[mm]	61	70	85	105	135	165	195
s	[mm]	12.5	16.5	20.5	24.5	30.5	36.5	42.5
Ø t	[mm]	13	17	21	25	32	37	45
Ø u	[mm]	20	26	32	40	48	57	65
v	[mm]	20	20	20	20	20	40	50
Screw DIN 912-8.8 (4 off)		M 12	M 16	M 20	M 24	M 30	M 36	M 42
Tightening torque	[Nm]	86	210	410	710	1450	2520	4050
Weight	[kg]	2.4	5.8	12.2	21.6	42.1	78	140
<b>Part no.</b>		<b>825030000</b>	<b>825040000</b>	<b>825050000</b>	<b>825060000</b>	<b>825070000</b>	<b>825080000</b>	<b>825090000</b>

### Accessories

Drill bushings DIN 179	[mm]	12 x 12	17 x 16	21 x 20	26 x 20	32 x 25	38 x 30	44 x 30
<b>Part no.</b>		<b>3300285</b>	<b>3300287</b>	<b>3300288</b>	<b>3300289</b>	<b>3300420</b>	<b>3300430</b>	<b>3300440</b>

\* Version with 30 kN clamping pressure: Lubricating nipple protrudes by 9.5 mm

\*\*Version with 50 kN clamping force: Lubricating nipple protrudes by 5 mm

Other sizes available on request.

# Arch clamps with position monitoring at the side and mechanical lock

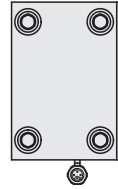
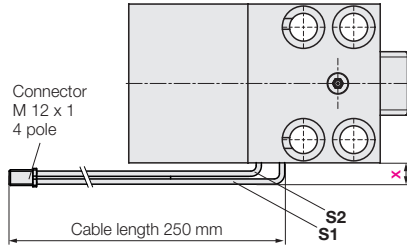
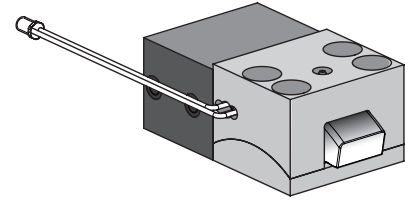
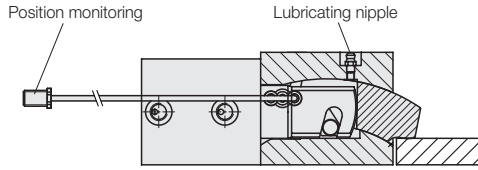

### Description

The proximity switches are installed in the guide housing. They are activated by means of the clamping bolt. The positions of the bolt in off-position or in clamping position are displayed.

- S1:** Clamping bolt in unclamping position
- S2:** Clamping bolt in clamping position
- S2 is overrun:** Clamping bolt in final position (message for no mould/die available or mould/die not clamped)

Special versions with signal up to final bolt position are available on request.

### Technical data

Temperature resistance up to 100 °C

Max. clamping force [kN]	30*	50**	80	125	200	310	450
x Position monitoring [mm]	12	5	0	0	0	0	0
Part no.	825030100	825040100	825050100	825060100	825070100	825080100	825090100

\* Version with 30 kN clamping pressure: Lubricating nipple protrudes by 9.5 mm  
 \*\* Version with 50 kN clamping force: Lubricating nipple protrudes by 5 mm

### Accessories

#### Connecting cable with screw coupling

Cable length 5 m **Part no. 5700013**

Cable length 10 m **Part no. 5700014**

#### Pin assignment 4-pole

