

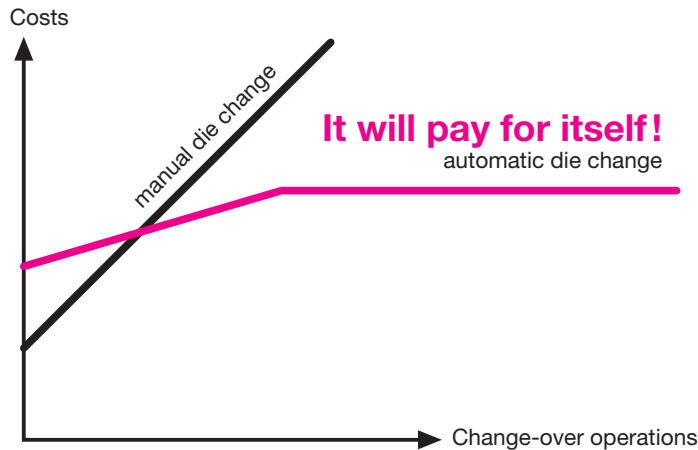

Advantages of Die Clamping Systems

Why die clamping systems?



Innovative technology and many years of experience are the basis for our range of die clamping and changing systems.

Rationalise your operation by using automatic die changing systems.

Increased productivity

- more capacity thanks to reduced set-up times
- less downtime, e.g. due to tool breakage or reworking the die
- short test period

Automation

- power-operated elements
- monitoring elements, in particular for pressure and position
- short cycles thanks to automatic triggering of functions
- integration with process monitoring and control

Increase in quality

- consistent quality
- repeatability of die position
- low-distorsion clamping

Operating facility

- operate under extreme circumstances (high temperature, spray)
- clamping in barely accessible positions without any problems
- clamping using high clamping forces
- dies may be changed by relatively unskilled workers
- repeatable die change process

Efficiency

- short set-up times even for small batches, smaller stock of parts
- simplified die change, also for the machine operator
- fewer jigs and fixtures required
- enhanced tool life as a result of less wear
- reduced run-in period for moulds and dies, i.e. fewer test pieces and less time required

Reduced rate of wear

- uniform and low-distortion clamping with high clamping forces
- compensating clamping force (elasticity)
- repeatable positioning and clamping process
- optimum selection of clamping points

Clamping principles

Clamping principles

Clamping examples

Clamping element

Product group

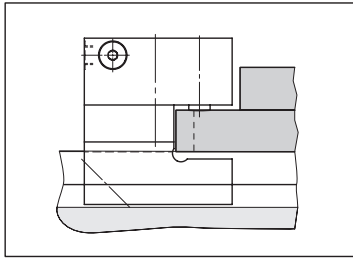
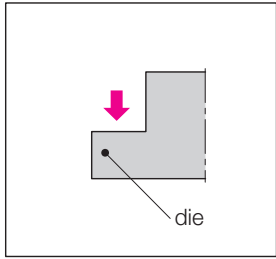

sliding clamp, angular clamp, clamping bar,
hollow piston cylinder
wedge clamp / flat clamping edge
spring clamping cylinders
extending clamps
high-pressure spindles

2 + 3

6

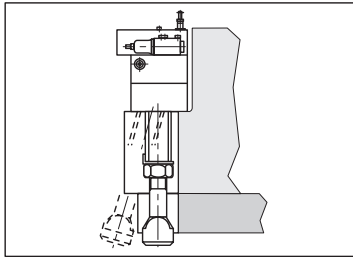
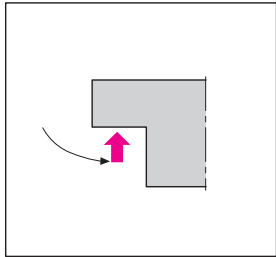

pivot and pull clamps
wedge swing clamps
electro-mechanical clamping elements

2 + 5

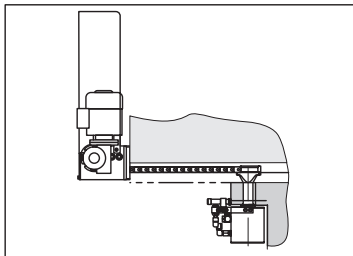
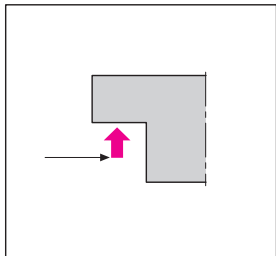

rapid-clamping systems with push chain
hollow piston cylinders
angular clamps, electro-mechanical

3

5

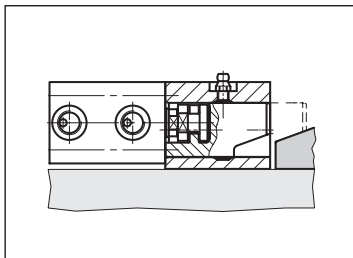
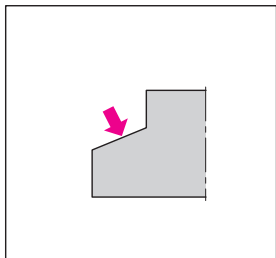

wedge clamps / tapered clamping edge

2

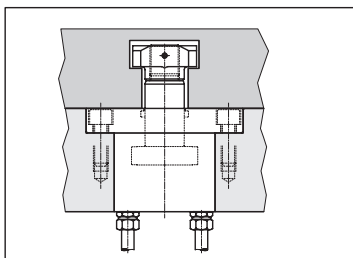
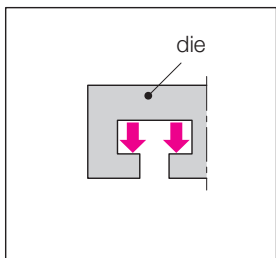

double-T clamping bars
pull clamps

2 + 4

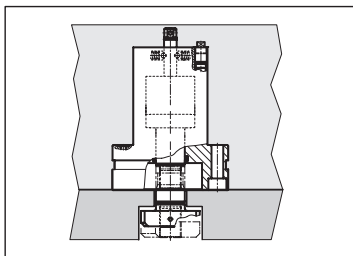
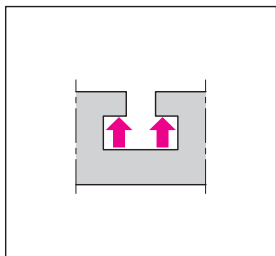

swivel and pull clamps, hydraulic
swivel and pull clamps, electrical
swivel sink clamps
swing clamps

4 + 5

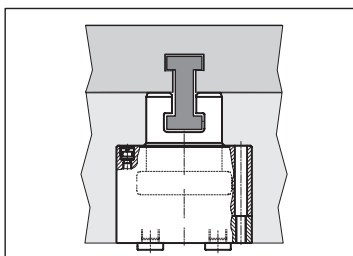
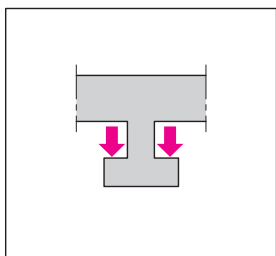

pull clamps with T-slot

4

T-slot dimensions as per DIN 650

Dimensions and tolerances for T-slots as per DIN 650. Applicable to machine beds, pallets or die clamping fixtures on presses

a	[mm]	14 H12 (14+0,18)	18 H12 (18+0,18)	22 H12 (22+0,21)	28 H12 (28+0,21)	36 H12 (36+0,25)
f min.	[mm]	12	16	20	26	33
f max.	[mm]	19	24	29	36	46
b	[mm]	23 ⁺²	30 ⁺²	37 ⁺³	46 ⁺⁴	56 ⁺⁴
c	[mm]	9 ⁺²	12 ⁺²	16 ⁺²	20 ⁺²	25 ⁺³
h min.	[mm]	23	30	38	48	61
h max.	[mm]	28	36	45	56	71
n max.	[mm]	1.6	1.6	1.6	1.6	2.5

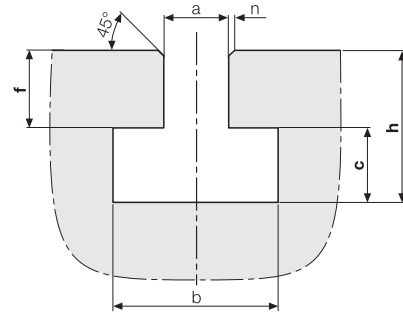

The **slot depth h** and the **web height f** must be exactly measured and checked for possible tolerances. If your T-slot is not within the specified tolerance range, customised solutions are also possible.

Recommended clamping forces for T-slots as per DIN 650

T-slot	Clamping force max.
14 mm	40 kN
18 mm	60 kN
22 mm	60 kN
28 mm	100 kN
36 mm	160 kN

Important note

If the above clamping forces are exceeded, permanent deformation of the T-slots may be caused.

Influence of the clamping situation on the forming process

Vibrations in forming dies result in an increased wear of dies and a reduced workpiece quality. An optimum design of the clamping situation has a significant influence on the vibration behaviour and thus also the process stability.

A stiffer clamping of the die results in a minimisation of the accelerations and vibrations. A stiffer clamping is obtained by the number of clamping points and an optimum force application close to the process force in the die. The system rigidity can be considerably increased with swing sink clamps which, due to their design, apply force close to the die centre. Even with the same number of clamping points, the vibration or die bending of the lower die can be reduced with the use of hydraulic or magnetic rapid clamping systems by up to 50% compared to traditional clamping elements such as screws or clamps.

This improvement is due to the shortening of the lever arm between the process force and the clamping point.

Clamping situation in comparison

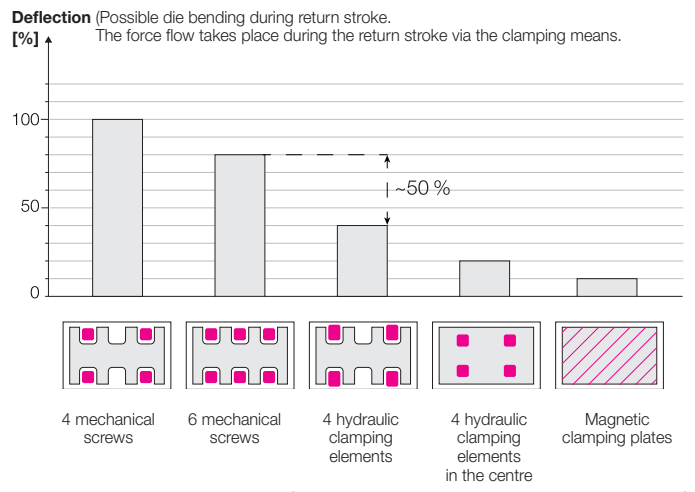

- uniform application of force
- considerably higher punctual clamping force
- improved rigidity of the clamping situation

Clamping force

Thread, property class 8.8		M6	M8	M10	M12	M14	M16	M20	M24	M30	M36	M42	M48
Admissible test load as per DIN 267 sheet 3 [kN]		12	21	34	49	67	91	143	205	326	478	652	856
Max. admissible preload (utilising 2/3 of the yield point)	[kN]	8	14	23	32	45	60	95	136	217	318	434	570
Required tightening torque	[Nm]	9	22	44	76	120	190	380	620	1200	2100	3400	5000
Maximum manual clamping force*	[kN]	8	14	23	32	45	56	67	70	70	70	70	70
Clamping force using a clamping arm (leverage = 2:1)	[kN]	5	9	15	21	30	37	44	46	46	46	46	46
Number x piston Ø for obtaining the preload specified in line 3 at 400 bar [mm]		1 x 16	1 x 20	1 x 25	1 x 32	1 x 40	1 x 44 2 x 32 3 x 25	1 x 55 2 x 40 3 x 32	1 x 63 2 x 50 3 x 40	1 x 80 3 x 50 4 x 40	1 x 100 4 x 50 6 x 40	1 x 120 2 x 80 6 x 50	1 x 140 3 x 80 8 x 50
Mechanical clamping and unclamping time per clamping point**	[s]	11	12	13	15	17	18	22	26	36	(50)	(70)	(100)
Hydraulic clamping and unclamping time per clamping point ***	[s]	0.8	0.9	1.0	1.1	1.2	1.3	1.5	1.8	2.2	3.0	4.0	5.0

Recommendations	If there are several clamping points, hydraulic clamping is recommended	Transition from manual to hydraulic clamping	Max. admissible clamping force cannot be achieved manually; hydraulic clamping is preferred	Manual clamping is no longer appropriate; hydraulic clamping only
------------------------	--------------------------------------------------------------------------------	-----------------------------------------------------	----------------------------------------------------------------------------------------------------	--------------------------------------------------------------------------

* Clamping force that can be achieved manually using a wrench as per DIN 894, by applying a manual force of 150 N and a coefficient of friction of 0.14.

** Total time required in case of mechanical clamping and unclamping to obtain the clamping force specified in line 5, without taking account of time required for providing single components. Clamping stroke = 6 mm.

When **working overhead** or when using **clamping claws**, the clamping and unclamping time must be increased by about 50%.

*** Total time required for hydraulic clamping and unclamping to obtain the clamping force specified in line 3. Electric power unit with solenoid valves. Flow rate 40 cm³/s at 400 bar. Clamping stroke 6 mm.

Clamping times for other clamping strokes

Time for mechanical clamping = $\frac{t \times h}{6}$ [s]

Time for hydraulic clamping = $\frac{t \times h \times m}{6}$ [s]

t = Clamping time specified in lines 8 and 9

h = Clamping stroke [mm]

m = Stroke factor 0.8 for stroke > 6mm
Stroke factor 1.2 for stroke < 6mm

Calculations

Clamping time $t = \frac{q \times s \times z}{16 \times Q}$ [s]

Piston speed $v = \frac{160 \times Q}{A \times z}$ [mm/s]

Flow rate of the pump $Q = \frac{q \times s \times z}{16 \times t}$ [l/min]

Motor rating for continuous operation $P = 2,7 \times n \times V \times p$ [W]

Pressure loss in pipes $\Delta p = \frac{1 \times L}{4 \times d} \times v^2$ [bar]

t = Clamping time [s]

q = Oil required per 1 mm piston stroke as per catalogue [cm³/mm]

s = Clamping stroke [mm]

z = Number of clamping cylinders

Q = Flow rate of the pump [l/min]

A = Piston area [cm²]

n = Motor speed [min⁻¹]

V = Flow rate of the pump [l/rotation]

p = Operating pressure [bar]

Assumed: λ = 0.055, p = 700 Ns²/m⁴, volumetric efficiency = 0.96, motor efficiency = 0.88

L = Pipe length [m] (straight, smooth pipe)

d = Pipe inner diameter [mm]

v = Flow velocity [m/s]

v_{max.} = 6 m/s for pressure pipes, 2 m/s for return pipes

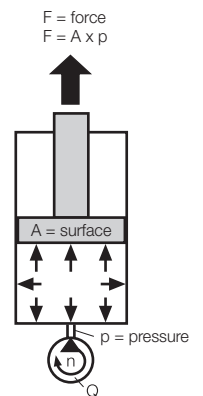

The clamping force to be applied for upper and lower die or mould depends on:

- the **retraction force** on the ram
- the **ejection force**
- the **acceleration force**
- the **die weight**

The total clamping force to be produced by the clamping elements must be higher than **the greatest of all forces acting in a specific case**. In general, the following approximate value may be assumed as the **total clamping force for the upper or the lower die**:

Total clamping force = 10 % to 20 % of the pressing force

Based on the total clamping force, the required number of clamping elements is determined taking account of their clamping force and local conditions (symmetry, clearance, etc.).

Retraction force on the ram

A more targeted design is possible based on the retraction force of the ram that must be completely covered by the total clamping force. The retraction force is the force acting on the die's clamping points after deduction of losses due to friction and acceleration. In the case of die casting machines, this force is referred to as the opening force. In a specific case, it must be checked whether this force has to be taken into consideration when designing the clamping elements. Under normal operating conditions, the full machine potential is not utilised. Often it only becomes evident when the die halves have become stuck. The clamping elements must be designed in such a way that they are not damaged or broken in such cases of emergency. (Approximate values as per VDI guidelines 3145, see below)

Ejection force

If ejectors are used, the maximum occurring ejection force must be taken into account. The ejection force acts on the die, if the ejector cylinders do not move against their own stops but when the die is used as stop. Thus, ejection forces must be considered in any case. (Approximate values as per VDI guidelines 3145, see below)

Approximate values as per VDI guidelines 3145

- Retraction force on the ram: 5 % to 20 % of the pressing force
- Ejection force in the bed: 5 % to 20 % of the pressing force
- Ejection force in the ram: 1 % to 10 % of the pressing force

Acceleration force

The acceleration force has to be taken into account, when using unusually heavy dies and/or high ram acceleration. The acceleration depends on the press drive, on the mechanical properties (elasticity, rigidity) of the press frame and on the operations being carried out.

The following approx. values may be assumed:

- for high-speed automatic punching presses approx. 50 g
- for open-front presses 30 g
- for car body presses 6 g

For determining the occurring acceleration force, the die weight must be known. The interrelation is shown in the diagram below:

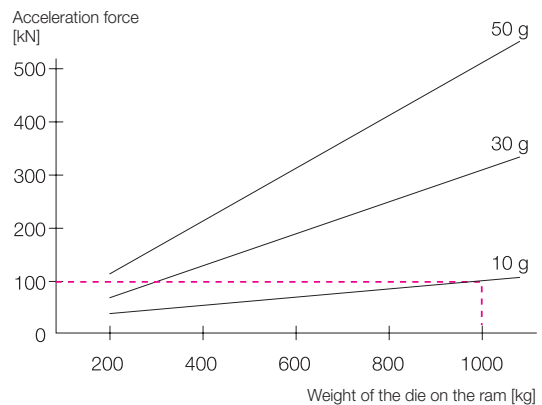

Calculation example

- Hydraulic double-column press without drawing operation
- max. retraction force 400 kN
- weight of upper and lower dies 1,000 kg each

Approximate value for the total clamping force per die half:

20 % of the pressing force = approx. 400 kN.

As per acceleration force:

with an acceleration of 10 g and a weight of 1000 kg, the acceleration force (as per diagram) is approx. 100 kN.

In view of the low acceleration force, the clamping force is determined on the basis of the retraction force.

Thus, the required total clamping force is **400 kN**.

Assistance in reaching a decision:

When does an investment pay for itself?

The subject of quick die changing on forming presses and injection moulding machines should not be interpreted too closely. The term 'change' includes the complete part of the process which is capable of being automated, i.e. feeding to and positioning in the machine, clamping and transporting outside the machine and, in a broader sense, also storage of dies.

We offer system solutions which are suitable for adaptation to customers' specific needs.

There may be many reasons for automation, the degree being dependent of the criteria prevailing in a company with respect to production and to the working place.

A decision for automation may be influenced by the following criteria:

- Improvement of productivity
- Minimisation of set-up times
- Increase of flexibility
- Rationalisation measures
- Humanisation of the working place
- Increase in quality
- Safety

This means that the decision for an automation of the die changing process is not only taken on the basis of a cost-benefit analysis but it is also influenced by working place related optimisation approaches.

In order to approach a solution by taking account of both quantity- and quality-related aspects, the so-called **benefit analysis** may be applied. This method for an alternative assessment offers the possibility of including also those criteria which cannot be expressed in units of money.

Besides the fixed and variable costs of an investment, also qualitative characteristics can be considered, such as:

- guarantee conditions
- availability of spare parts
- safety
- service life
- advice and training
- ease of operation
- environmental compatibility, etc.

For each criterion included, an evaluation is determined which reflects the importance of the criterion concerned.

In the second step, each alternative relevant for the decision is assigned a mark, based on its compliance with the various criteria.

Overall benefit

By multiplying these dimensionless figures, a partial benefit is obtained for each criterion. Addition of the partial benefit obtained for the alternative under consideration will give the overall benefit

In the example, two alternative solutions for press automation are at choice. Using this model of benefit analysis (scoring model) decisions can also be made taking account of quality criteria.

Although the price of die changing system B does not meet with expectations (assigned degree of compliance = 3), this alternative has a higher overall benefit. For more details, we recommend reference to examples on the Internet, keyword: benefit analysis.

When simply comparing costs, only the investment costs of two or more alternatives are compared with the anticipated benefit.

Criterion	Evaluation %	Die changing system A		Die changing system B	
		Degree of compliance ²⁾	Value of benefit	Degree of compliance	Value of benefit
Acquisition costs	25	8	2.00	3	0.75
Maintenance	20	4	0.80	6	1.20
Safety	30	5	1.50	9	2.70
Operation	15	2	0.30	10	1.50
Spare parts	8	5	0.40	9	0.72
Training	2	3	0.06	9	0.18
Overall benefit	100	–	5.06	–	7.05

2) The degree of compliance is expressed in marks between 1 and 10, 10 being the best.

Calculation of payback period

In this method, the acquisition costs (purchase price, calculatory depreciation and interest), the operating costs (energy, maintenance, expenses for the room where the machine is installed, follow-up costs for dies) as well as wage costs (set-up times, run-in period after die change) are calculated and, related to the planned die changing frequency, compared with the savings in time and costs.

Calculation example

Using the example of an existing press, two alternative proposals for die changing are compared. The production conditions are as follows:

- 2-shift operation, 810 minutes / day
- one die change per shift
- the dies are being used in the press
- roller bars and carrying consoles for loading the dies are already fitted to the press

Example A

Die change is carried out using ten M24 mechanical clamping screws on the ram and six M24 clamping screws on the bed.

The acquisition costs are negligible compared with alternative B.

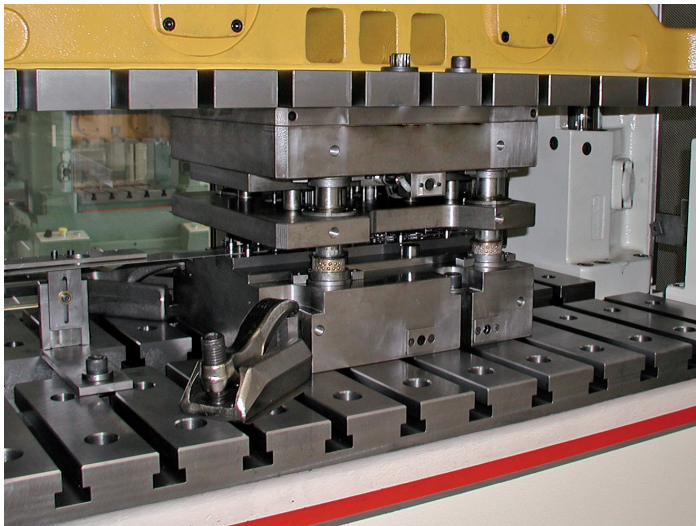

Example B

On the ram, die change is carried out using rapid clamping systems of product group 3, i.e. hollow piston cylinders type HILMA 82135 2802 (8x). On the bed, die change is carried out using clamping bars of product group 2 type HILMA 2095 120 (4x).



Calculation of payback period

		Example A	Example B
General data			
Transfer press (existing)	Piece(s)	1	1
Existing dies	Piece(s)	5	5
Planned dies	Piece(s)	3	3

Die changing system			
Clamping elements on the ram	EUR	0	3,200
Clamping elements on the bed	EUR	0	1,600
Hydraulic power unit (including control)	EUR	0	4,300
Installation / Commissioning	EUR	0	4,700
Rework of existing dies WZ	EUR	0	16,900
Costs of the die changing system	EUR	0	30,700

Set-up times			
Die clamping on the ram	min.	6.5	0.5
Die clamping on the bed	min.	3.9	0.5
Die unclamping on the ram	min.	6.5	0.5
Die unclamping on the bed	min.	3.9	0.5
Die transport	min.	4.0	4.0
Die set-up times	min.	24.8	6.0

Die change			
Die changes / shift	Number	1	1
Manpower / number of die changes	Number	1	1
Set-up time / month	h	17.3	4.2

Hourly machine rate	EUR/h	280	280
Set-up costs / month	EUR	4,844	1,176
Set-up costs / year	EUR/year	58,128	14,112

Hourly wage	EUR/h	25.56	25.56
Wage costs / year	EUR	5,306	1,288

Calculatory depreciation	years	10	10
	EUR/year	0	3,070

Calculatory interests	EUR/year	0	767
------------------------------	----------	----------	------------

Sum of costs	EUR/year	63,434	19,237
---------------------	----------	---------------	---------------

If die change is carried out once per shift, about 500 die changes are carried out per year.

Die change	Number/year	500*	500
Costs / change	EUR	126.87	38.47
Cost benefit	EUR/change	88.40	

Amortisation after die changes ~ 347 die changes (30,700 EUR : 88.40) this corresponds to approx. 8,33 months

* 500 die changes/year = 2 die changes/day x 250 working days

Under the given marginal conditions, an investment of 30,700 EUR quoted as an example in alternative B will have paid off after approx. 8.33 months or 347 die changes.

The production time gained by the reduction in the set-up times has not been taken into account.

Rough calculation

As a first approach, the following formula can be used for determining the payback period with sufficient accuracy:

Payback period =

$$\frac{\text{Costs}}{\text{Benefit}} = \frac{\text{Invest. (quick clamping)} - \text{Invest. (conventional)}}{\text{Saving of time} \times \text{machine hour rates} \times \text{die change}}$$

Parameters:

- Investment costs (quick die clamping/changing system B) [EUR]
- Investment costs (conventional clamping/changing system A) [EUR]
- Saving of time = quick die clamping [min] - conventional clamping [min]
- Hourly machine rate [EUR/min]
- Die changes [changes/month]
- Payback period [months]

For the above example, a rough calculation gives the following results:

$$\text{Payback period} = \frac{(30,700 - 0)}{(24.8 - 6) \times (280 / 60) \times (500 / 12)}$$

$$= \mathbf{8.39 \text{ months}}$$

The payback period of 8.39 months determined by this method is almost identical with the payback period determined by way of calculation and thus is sufficiently accurate.

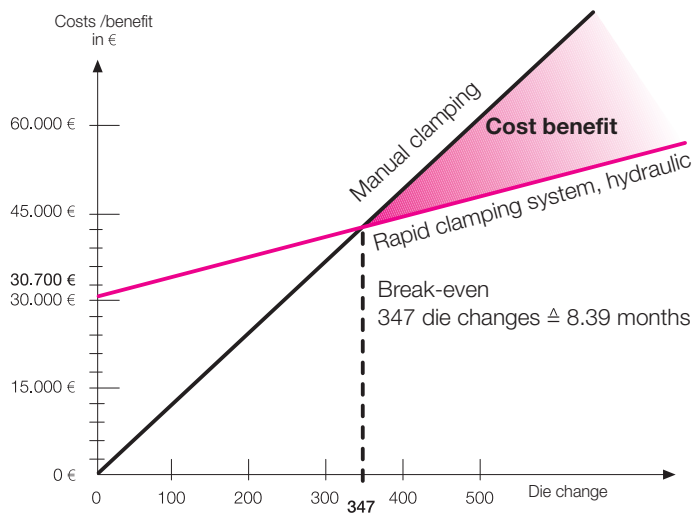

Information in the catalogue

All information following VDI guideline 3267 to 3284
 Terms and symbols as per DIN ISO 1219
 Dimensions in SI units as per DIN 1301
 Dimensions without tolerances as per DIN 7168 medium

Clamping elements

Continuous operating pressure	see catalogue sheets
Ambient temperature	-10 °C to 70 °C (others on request)
Mounting position	any, if not otherwise stated
Stroke speed	0.01 – 0.25 m/s
Leakage rate	at 400 ar, 20 °C, Hydraulic oil HLP 32
- dynamic	0.0001 g per double stroke (Ø = 32, stroke = 40, V = 0.1 m/s)
	0.0003 g per double stroke (Ø = 40, stroke = 40, V = 0.1 m/s)
- static	0.03 g in 24 hours

Oil recommendation

Oil temperature [°C]	Description as per DIN 51524	Viscosity as per DIN 51519
0 – 40	HLP 22	ISOVG 22
10 – 50	HLP 32	ISOVG 32
20 – 60	HLP 46	ISOVG 46

(other hydraulic fluids are available on request)

Influence of temperature

All fluids expand differently with increasing temperature. If no space is available for expansion, the change results in a pressure increase. Since the clamping system is a closed system, there will be a pressure increase.

Conversely, a decrease in temperature results in a decrease in pressure. As a rule of thumb one can say that a 10 °C increase in temperature results in a 100 bar increase in pressure. In the case of a significant decrease in temperature, e.g. during the night in unheated workshops, the pressure will decrease accordingly. It is therefore recommended that systems which are isolated from the pressure generator are fitted with a pressure accumulator to reduce any decrease in pressure.

Fittings

as per DIN 2353. Screwed plugs form B as per DIN 3852 sheet 2 (sealing by sealing edge). Do not use additional sealing materials such as Teflon ribbon!

Connecting thread

British standard pipe thread (Withworth form) with screw hole form X as per DIN 3852 sheet 2 (for cylindrical screwed plugs)

Pipes

Seamless smooth steel pipes as per DIN 2391 NBK.
 Preferably:

Outer Ø [mm]	Wall thickness [mm]	Oil pressure [bar]	Fitting
8	1.5	400	G 1/4
8	2.0	500	G 1/4
12	2.5	400	G 3/8
12	3.0	500	G 3/8
16	3.0	400	G 1/2

Pipes should be designed as short as possible. The length of pipes for single-acting cylinders with a spring return should not exceed 5 m, pipes for double-acting cylinders may be longer. Make sure that pipes are installed with a large bending radius.

Hose connections

For connection of the clamping elements, we recommend high-pressure hoses with 4 x safety factor at an operating pressure of 500 bar. Special designs should be used for hoses subject to constant movement, e.g. hoses for oil supply to the ram. When installing hoses, observe the minimum bending radii.

Start-up, maintenance

Read the operating manual before starting the system. Only use fresh and clean oil. Bleed the complete system by operating the pump at low pressure (approx. 20 bar) until the oil which emerges at the highest point is free from bubbles (rinsing). Since hydraulic valves are very sensitive to dirt, make sure that no impurities are carried into the hydraulic oil. A change of oil should be carried out once a year.

Dynamic pressure in the hydraulic system

Due to friction in pipes, screw fittings, valves and cylinders, a pressure of 1 to 2 bar is necessary for proper oil circulation. The retracting springs in cylinders with a spring return are designed for a maximum dynamic pressure of 2 bar. If the cylinders move slowly, or if they do not retract properly, the dynamic pressure must be reduced (larger pipe diameter, shorter pipes, fewer screw fittings, connection in parallel rather than in series, reduced weight on the piston).

In applications with double-acting cylinders, dynamic pressure is likely to occur when pressure is applied to the rod side and the larger oil volume from the piston side must flow back to the oil reservoir through narrow pipes and valves.

Normally, dynamic pressure has no negative effect. However, in applications with swing clamps and swing sink clamps the drop is in excess of 50 bar, this may cause premature wear of the swing mechanism and result in a malfunction (see catalogue sheets).

Safety levels

Safety levels are determined by different safety requirements and manufacturing technologies.

Hydraulic die clamping systems can be classified into one of three safety levels:

Safety level no. 1

Preferably used for presses with column-guided dies.

Pressure switches in every clamping circuit for monitoring the clamping force, used for machine safety.
Two independent hydraulic circuits.

Clamping circuit = 50 % of the clamping elements in bed and ram.

Safety circuit = 50 % of the clamping elements in bed and ram.

If one circuit fails, the upper or lower die is still clamped with 50 % of the total clamping force.

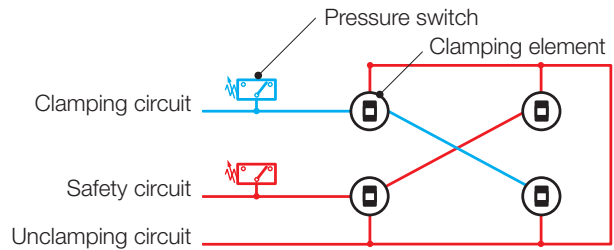

Safety level no 2

For presses with dies which are not column-guided.

A check valve (pilot operated) maintains pressure in the clamping and safety circuits even when the pressure drops in the remaining system.

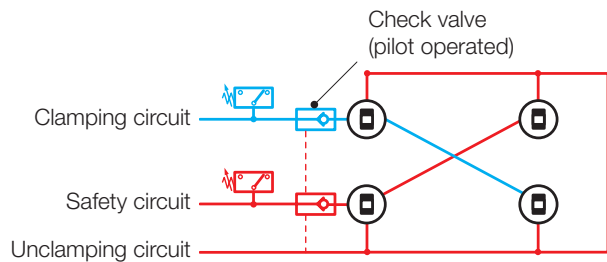

Safety level no. 3

For power presses and car body presses with dies which are not column-guided.

All clamping elements are secured by pilot-operated check valves. If pressure drops by more than 20 % of the operating pressure, the pressure switch stops the press. The check valves maintain the clamping force for many days.

