



Power unit

ready for connection*, energy-saving intermittent cycling
max. flow rate 0.82/2.1/3.5 l/min, max. operating pressure 500/250/160 bar



Advantages

- Very compact design
- Energy-saving intermittent cycling
- Many control variants
- Electronic pressure switch
- Digital pressure display
- Quick pressure adjustment by teach-in function
- Electric control optimally adapted
- High-quality leakage-free poppet valves
- Pressure generator also without valves available
- Useful accessory already mounted
- Alternatively manual switch or foot switch
- Ready for connection*

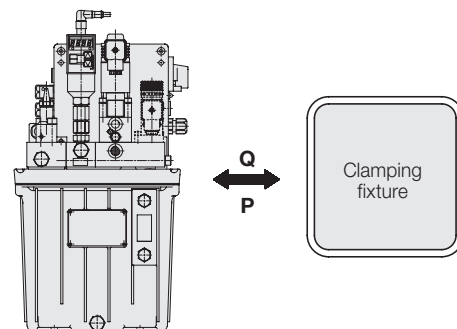

Application

These power units are especially suitable for the operation of small to medium-sized hydraulic clamping fixtures. Maximally two clamping circuits for single or double-acting cylinders are available, that can be controlled independently of each other. Thereby also "shuttle machining" is possible, i.e. that during machining of the workpiece in one fixture, workpiece change on the second fixture can be made.

Description

A special feature is the mounting of pump and electric motor in the reservoir. Thus hydraulic and electric control can be arranged in a space-saving way and easily accessible on the reservoir cover. The modular design enables a multitude of control variants. The radial piston pump is available with three different flow rates and operating pressures. To allow an energy-saving intermittent cycling only leakage-free poppet valves are used.

Energy-saving intermittent cycling

The electric motor is only running, as long as hydraulic oil is really required, that means to

- extend and retract the clamping cylinder
- build up the operating pressure

Example
Pressure-time diagram for single-acting clamping cylinders

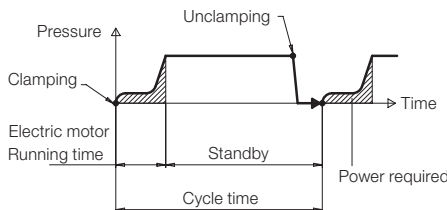

In this example of a hydraulic clamping fixture the running time of the electric motor corresponds to the clamping time, which is only a few seconds. In standby mode the power consumption is relatively low (see Electrical data). Prerequisites are leakage-free clamping elements, valves and accessories. The pressure control is made by an electronic pressure switch, that switches on the electric motor for a short time in case of a pressure drop.

Control variants

1 clamping circuit

single acting

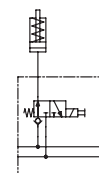

double acting

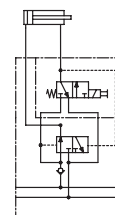

2 clamping circuits

single acting

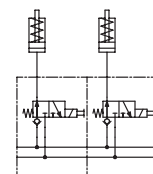

double acting

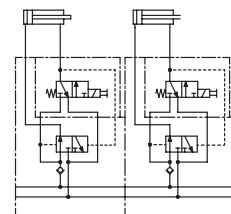

Without valve

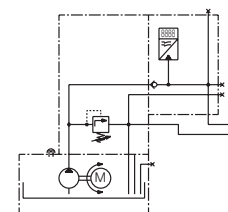

Important notes

These power units are exclusively designed for the industrial use of pressure generators for hydraulic clamping fixtures that allow intermittent cycling (see example). All connected hydraulic components must be leakage-free and designed for the maximum operating pressure of the power unit. The power unit supplies very high pressures. The connected clamping cylinders generate very high forces so that there is a permanent danger of crushing in the effective area of the piston rod. The manufacturer of the fixture or the machine is obliged to provide effective protection devices. Installation, start up and maintenance have to be made according to the supplied operating instructions by authorised experts.

Safety features

- Operating pressure infinitely adjustable, therefore precisely defined clamping force
- Electronic pressure switch with digital pressure display
- Repeatability ± 1 bar
- Pressure drop max. 10 %
- Hermetically sealed poppet valves
- Screen disks in the valve ports
- No pressure drop in case of power failure (see page 4)
- Control voltage 24 V DC
- Machine tool interlock (optional)
- Oil level and temperature control (optional)

*** Delivery**

The power units are delivered ready for connection, i.e. after filling of hydraulic oil and connection of the hydraulic and electric lines they are ready for operation.

Dimensions Technical data

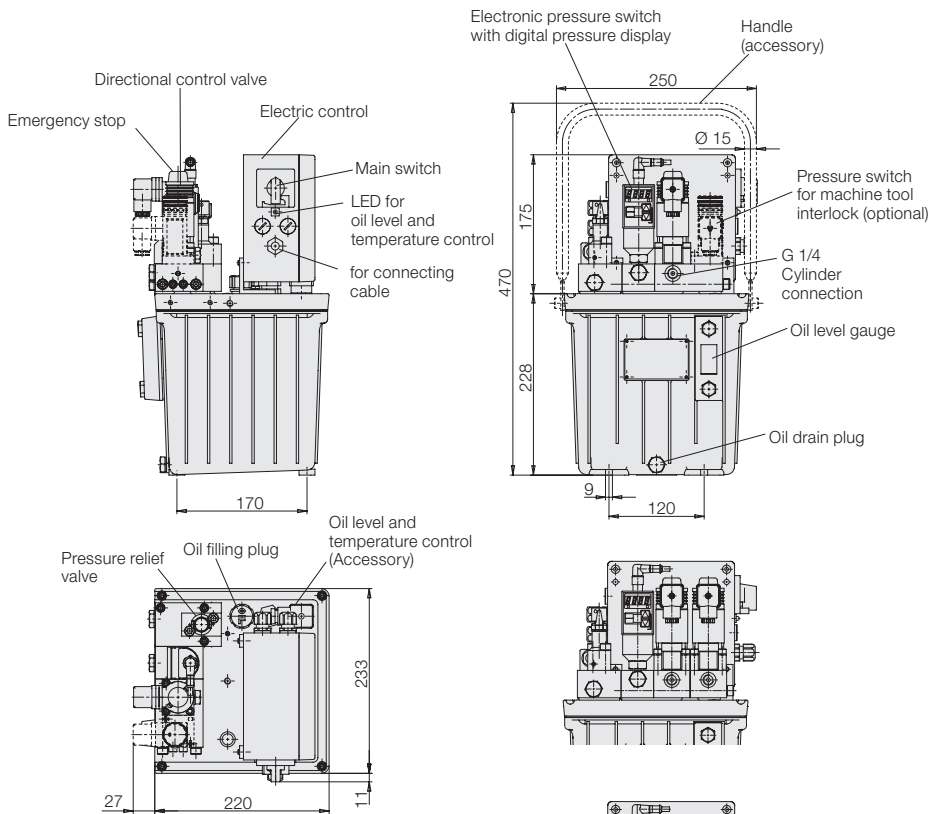

Switch (Clamping-Unclamping)

The power units are alternatively delivered with connected manual or foot switch (see chart). The pilot light in the switch signals:

1. Switch in clamping position
2. The adjusted clamping pressure is available

Important note!

This message signals that the clamping pressure is available at the electronic pressure switch of the power unit. The actual pressure of the clamping fixture can only be controlled by an installed pressure switch installed on the fixture (see machine tool interlock).

Manual switch

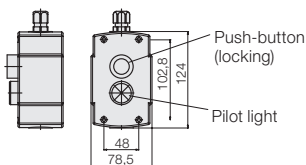

Foot switch

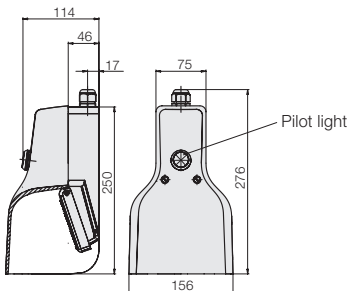

For start up it is imperative to pay attention to the supplied operating instructions!

Note

Power unit with manual switch for coupling systems see data sheet F 9.425.

Hydraulic circuit diagrams

SA = Single-acting cylinders

DA = Double-acting cylinders

MI = Machine tool interlock by additional pressure switch

SA + MI (optional)

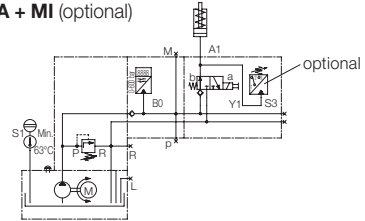

2 x SA

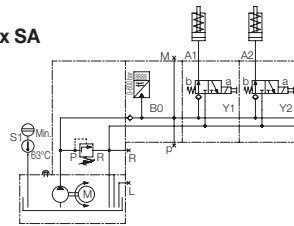

2 x SA + 2 x MI

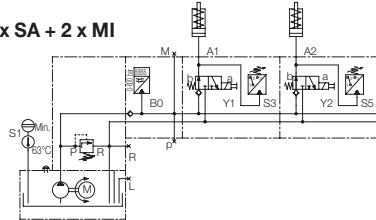

DA + MI (optional)

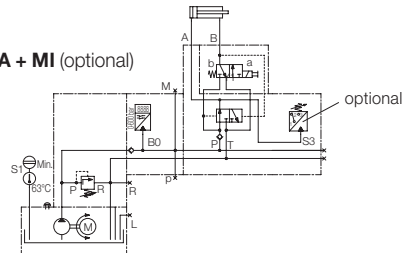

2 x DA

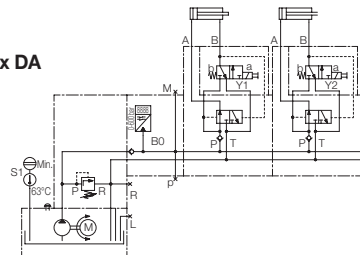

2 x DA + 2 x MI

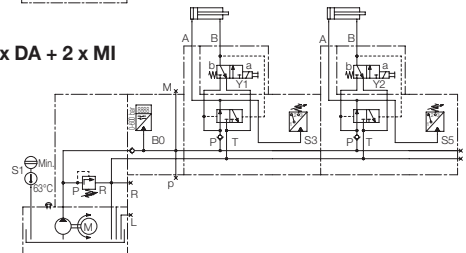

Without valves

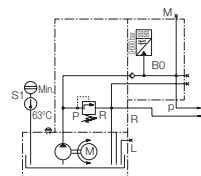

Versions Options • Accessories

Cylinder type SA / DA without / with Pressure switch MI* (at power unit)	Directional control valve		Electric control	Terminal box	Manual switch	Foot switch	with- out	Flow rate / max. operating pressure			Weight [kg]
	3/2	4/2						13.67	35	58.5	
				0.82	2.1	3.51					
				500	250	160					
							Part no.	Part no.	Part no.		
	1		•		1		8405 121	8405 221	8405 321	29.5	
	1		•			1	8405 122	8405 222	8405 322	30.5	
	1		•				8405 131	8405 231	8405 331	28.5	
	1		•	•			8405 141	8405 241	8405 341	28	
	1		•		1		8405 181	8405 281	8405 381	30.5	
	1		•			1	8405 182	8405 282	8405 382	31.5	
	1		•				8405 187	8405 287	8405 387	29.5	
	1		•	•			8405 143	8405 243	8405 343	29	
	2		•		2		8405 105	8405 225	8405 325	31.5	
	2		•			2	8405 106	8405 226	8405 326	33.5	
	2		•				8405 113	8405 233	8405 333	29.5	
	2		•	•			8405 142	8405 242	8405 342	29	
	2		•		2		8405 185	8405 285	8405 385	32.5	
	2		•			2	8405 186	8405 286	8405 386	33.5	
	2		•				8405 189	8405 289	8405 389	31.5	
	2		•	•			8405 145	8405 245	8405 345	29	
		1	•		1		8405 109	8405 209	8405 309	30	
		1	•			1	8405 111	8405 211	8405 311	31	
		1	•				8405 112	8405 212	8405 312	29	
		1	•	•			8405 147	8405 247	8405 347	28.5	
		1	•		1		8405 117	8405 217	8405 317	31	
		1	•			1	8405 118	8405 218	8405 318	32	
		1	•				8405 119	8405 219	8405 319	30	
		1	•	•			8405 148	8405 248	8405 348	29.5	
		2	•		2		8405 107	8405 207	8405 307	32.5	
		2	•			2	8405 108	8405 208	8405 308	33.5	
		2	•				8405 115	8405 215	8405 315	31.5	
		2	•	•			8405 146	8405 246	8405 346	31	
		2	•		2		8405 137	8405 237	8405 337	34	
		2	•			2	8405 138	8405 238	8405 338	35	
		2	•				8405 139	8405 239	8405 339	33	
		2	•	•			8405 140	8405 240	8405 340	33	
-	-	-	•			8405 110	8405 210	8405 310	27.5		
-	-	-	•			8405 149	8405 249	8405 349	27		

*) Machine tool interlock

As an option, every clamping circuit is checked by an additional pressure switch, which has to be electrically connected directly to the control of the processing machine.

Messages:

- Clamping pressure available
→ Workpiece can be machined
- Clamping pressure dropped below 80 %
→ Stop machining immediately

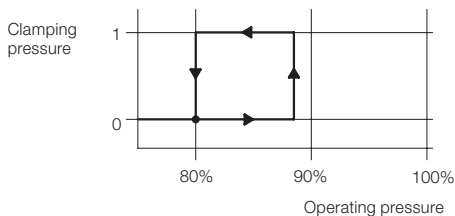

The switching point must be adjusted to 80% of the adjusted clamping pressure.

Note

If the pressure must be frequently changed, the electronic pressure switch is easier to adjust (identification letter "E").

Handle "B"

With the handle, the power unit can be easily transported by two persons to different places of installation.

Example of ordering

Power unit 8405 221 with handle

Part no. 8405 221B

Electronic pressure switch for machine tool interlock "E"

(instead of the mechanical pressure switch)

The lower switching point (80 % of the clamping pressure) of electronic pressure switches is firmly programmed and can be stored in teach mode for every desired clamping pressure by pressing a button.

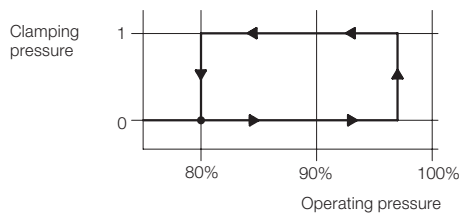

Example of ordering

Power units 8405-185 with two electronic pressure switches for machine tool interlock

Part no. 8405 185E

Oil level and temperature control "T"

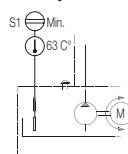

The oil level and temperature control is installed in the reservoir cover and electrically connected to the control box. In case of an error message, the control LED below the main switch is lit.

Possible errors:

- Oil filling quantity < 2.3 l
Shortage 0.7 l below the minimum oil level gauge.
Required refilling quantity min.1.5 l
- Oil temperature > 63 °C

Important note!

As long as the error message is available the electric motor does no longer start to avoid damages due to overheating. This means that in the case of a pressure drop the pump does not deliver!!!

Recommendation

Above all with automated operation the oil level and temperature control should only be used for machine tool interlock in combination with pressure switches. This is the only way to ensure that during the switch-off of the electric motor the workpiece machining will be interrupted in the case of a pressure drop of more than 20 %.

Example of ordering

Power unit 8405 238 with machine tool interlock and oil level and temperature control

Part no. 8405 238T

Different combinations

The three options described above are also available in combination. When placing the order please stick to the following sequence :

- "T" + "B" 8 4 0 5 - X X X T B
- "T" + "E" 8 4 0 5 - X X X T E
- "B" + "E" 8 4 0 5 - X X X B E
- "T" + "B" + "E" 8 4 0 5 - X X X T B E

Technical data Relative duty cycle

General data

Design	radial piston pump
Direction of rotation	any
Porting connection	fittings with G1/4 with screw-in plugs form B or E as per DIN 3852
Mounting	3 screws M 8
Mounting position	upright
Environment temperature	+5...+35 °C
Max. oil temperature	+60 °C
Noise level	max. 82 dB(A) (at a distance and height of 1 m above the ground standing on insulation felts)

Hydraulic data

Min. operating pressure	30 bar
Viscosity range	4...800 mm ² /s
Recommended viscosity range	10...200 mm ² /s
Recommended viscosity class	ISO VG 22 as per DIN 51524
Recommended hydraulic oil	HLP 22 as per DIN 51524-2 (not suitable for liquids of type HFA, HFB, HFC and HFD)

	Filling quantity	usable quantity
Content of the reservoir max.	5.0 l	3.2 l
Oil level gauge max.	3.8 l	2.0 l
min.	3.0 l	1.2 l
Electrical oil level control	2.3 l	0.5 l

Electrical data

Motor type	2-pole three-phase motor
Rating power	0.75 kW
Rated speed	2830 min ⁻¹
Supply voltage	3 ~ 230/400 V ΔY 50 Hz ± 10 %
Nominal current at 400 V	2 A
Power factor cos φ	0.82
Standby	
Power consumption "Clamped"	5 W
"Unclamped"	28 - 50 W
Isolation class	B as per VDE 0530
Main switch	with thermal overload protection, can be padlocked
Control Electric motor	circuit breaker, control by pressure switch
Control voltage	24 V DC
3/2 directional control valve	controlled by manual switch or foot switch
Fuses external	required 3 x 6 A slow
internal	primary 2 x 4 A slow (5x30mm) secondary 1 x 2 A slow (5x20mm)
Code class	IP 54
Supply line required	4 x 1 mm ²
Manual switch	5 x 1 mm ² approx. 3m long
Foot switch	4 x 1 mm ² approx. 3m long
EMC	tested

Hydraulic control

The hydraulic control is designed for direct manifold mounting without pipes and consists of the following components:

The connecting block with pressure relief valve to adjust the desired operating pressure. The maximum operating pressure (chart page 3) is mechanically limited in the factory.

Series mounting plate with electronic pressure switch and digital pressure display to adjust the switch-off pressure for the electric motor. The adjustment is made in teach-in mode independent of the adjustment of the pressure relief valve.

A pressure drop of approx. 10 % will cause the pump motor to start again.

Series mounting plate with directional control valve for control of single or double-acting cylinders.

Alternative:

Series mounting plate with directional control valve and pressure switch for machine tool interlock (see page 3)

Valves

Only leakage-free poppet valves are used to allow the energy-saving intermittent cycling (see page 1). The electric control is designed for maximally two solenoid valves.

Single-acting cylinders

One 3/2 directional control valve per clamping circuit is directly operated by a manual switch or a foot switch.

Double-acting cylinder

The 4/2 directional control valve is a combination of an electrically and a hydraulically operated 3/2 directional control valve. The control is made by a manual switch or a foot switch.

Operation of two clamping fixtures

The control enables the operation of two clamping fixtures by means of two manual switches or two foot switches. Prerequisite is the same operating pressure of both fixtures.

Safety in case of power failure

The solenoid valves are de-energized in "clamping position". In the case of power failure this switching position is remained and thereby also the hydraulic pressure in the clamping line. A pressure drop is only to be feared with leaking clamping elements or valves.

Relative duty cycle

These power units are only suitable for intermittent cycling (intermittent cycling S3 as per VDE 0530).

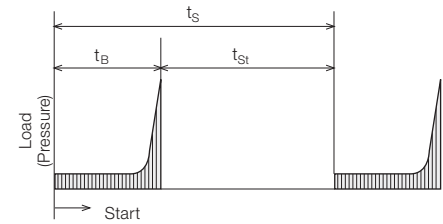

t_B = Running time of the electric motor from start to switching off (clamping time)

t_{St} = Downtime (workpiece machining time)

t_S = Cycle time

The relative duty cycle is

$$\% ED = \frac{t_B}{t_B + t_{St}} \cdot 100 = \frac{t_B}{t_S} \cdot 100$$

Example

Clamping fixture with double-acting cylinders

Clamping time

$$t_{B1} = 5s$$

Unclamping time

$$t_{B2} = 3s$$

Workpiece machining time

$$t_{St1} = 60s$$

Workpiece changing time

$$t_{St2} = 12s$$

Cycle time

$$t_S = 80s$$

Relative duty cycle

$$ED = \frac{t_{B1} + t_{B2}}{t_S} \cdot 100 = \frac{5s + 3s}{80s} \cdot 100 = 10\%$$

The maximum duty cycle is a function of the motor load. Apart from the load, the motor winding temperature of the submerged motor is in principle dependent on oil temperature and oil level. With maximum oil level, the complete winding is submerged in oil and optimally cooled. With decreasing oil surface a part of the winding is in the air. Since air is a poor heat conductor, the winding temperature increases considerably. Therefore the load of the motor must be reduced. The following chart indicates the relative cycle time as a function of the oil level in the reservoir. The maximum oil temperature of 60 °C must not be exceeded (see "Oil level and temperature control").

Maximum relative cycle time [%ED]

(at room temperature 23 °C)

Oil level	8405 1XX	-2XX	-3XX
maximum	5.0 l 40	25	20
minimum	3.0 l 25	20	16

Maximum running time of the electric motor [s]

(with different oil levels)

Reservoir

maximum	5.0 l	120 s	91 s	54 s
usable	3.2 l			

Anzeige

maximum	3.8 l			
usable	2.0 l	120 s	57 s	34 s

Anzeige

minimal	3.0 l	87 s	34 s	20 s
usable	1.2 l			