

Wedge Clamps for Flat Clamping Edge

double acting, operating force 35 up to 120 kN, hydraulic clamping and unclamping, without and with position monitoring at the side

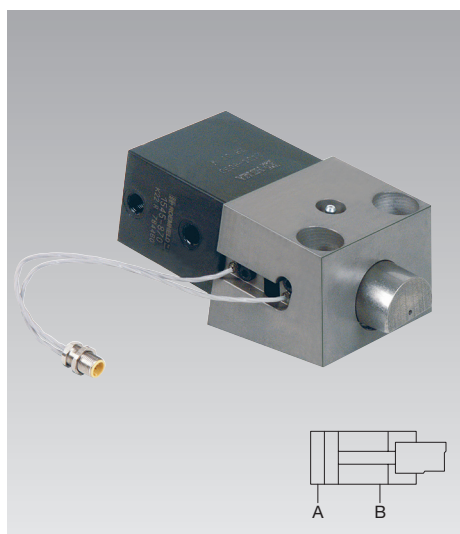

Advantages

- Safe clamping of dies with flat clamping edge
- Side loads are compensated by drill bushings
- High operational safety by position monitoring and automatic motion sequence
- Very sturdy and compact design
- Well-proven clamping element with high degree of safety and long service life
- Retracting clamping bolt ensures unrestricted mould and die change
- Minimum space requirement due to position monitoring without lateral overhang

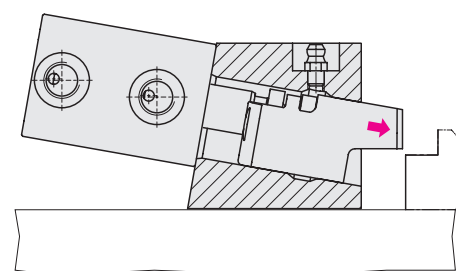

Application

Double-acting wedge clamps are particularly suitable for safe clamping of dies with flat clamping edge on a press bed or ram or for clamping dies in injection moulding machines with Euromap mounting grid.

Description

The wedge clamps consist of a hydraulic block cylinder connected with a clamping bolt in a floating manner.

Clamping cycle: the clamping bolt which is inclined by 5° performs an idle stroke and simultaneously a clamping stroke. The clamping bolt is lowered axially onto the clamping edge. The 5° angle of the housing has been determined so that the hydraulic pressure is sufficient for unclamping, despite the frictional engagement on the clamping edge.

Since the clamping force is axially transmitted to the clamping point, only low side loads occur. The wedge clamp is available with or without position monitoring.

Technical data

Max. operating force	[kN]	35–120
Max. clamping pressure	[bar]	50
Unclamping pressure	[bar]	200–350

Maximum operating force

This is the force that can be absorbed by the clamping element and the fastener (screws).

Important notes!

Please observe: in case of incorrect operation of the wedge clamps, the clamping bolt may fully retract into the guide housing and thus cause a die half falling off.

When using wedge clamps on the press ram or a vertical press, it is recommended that multiple-circuit hydraulic supply of the clamping elements and pilot-controlled check valves are used for securing hydraulic clamping.

The greasing intervals (high-temperature grease) should be scheduled in accordance with the operating conditions (at least once a week). Please note that greasing of the wedge bolts should only be made with the elements being retracted.

Versions

- without position monitoring
max. temperature: 160 °C
(300 °C on request)
- with position monitoring at the side
max. temperature: 100 °C

Position monitoring

The integrated position monitoring is coupled to the clamping bolt and signals:

1. Clamping bolt in unclamping position
2. Clamping bolt in clamping position
3. Error message when overrunning the clamping position

Application example

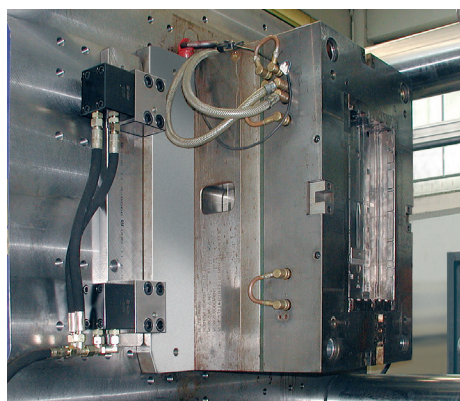

Dimensions Technical data

Wedge clamps

with position monitoring (at the side)

Clamping bolt with a 5° bevel

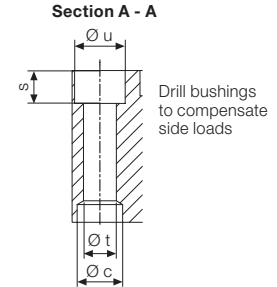
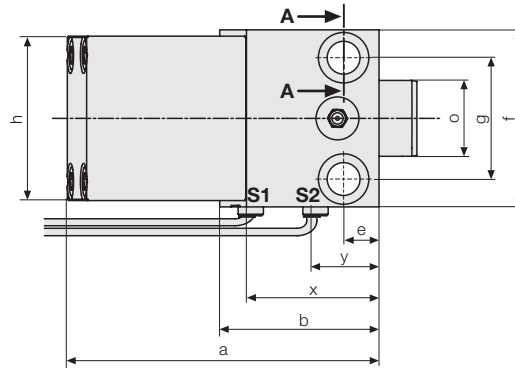
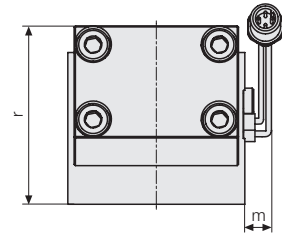
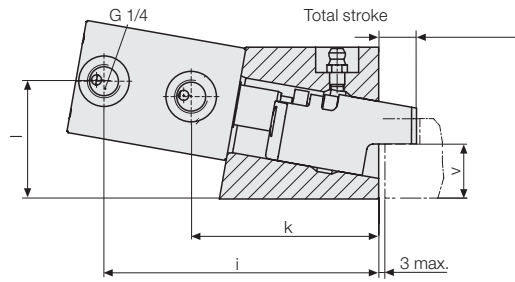
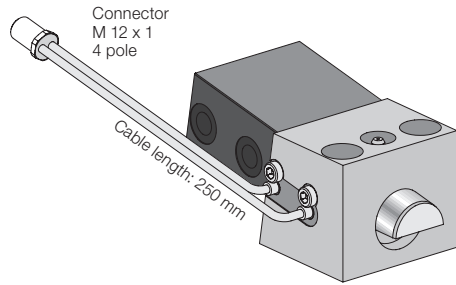

Position monitoring

(see catalogue sheet WZ 2.2460)

Mounting grid

Max. admissible operating force Screw DIN 912 8.8 [kN]	Standard			as per Euomap		
	35	60	120	35	60	120
Screw DIN 912 8.8 (4 off)	M12	M16	M20	M12	M16	M20
Clamping pressure max. [bar]	50	50	50	50	50	50
Unclamping pressure [bar]	200 – 350	200 – 350	200 – 350	200 – 350	200 – 350	200 – 350
Cylinder Ø [mm]	25	40	50	25	40	50
Total stroke [mm]	20	25	25	20	25	25
Max. oil consumption [mm]	10	32	50	10	32	50
Clamping stroke [mm]	12	16	17	12	16	17
a [mm]	123	160	197	123	176	197
Ø c H7 x depth [mm]	18H7 x 7	26H7 x 9	30H7 x 11	18H7 x 7	26H7 x 9	30H7 x 11
b [mm]	60	78	109	60	95	109
e [mm]	14	16	20	15	33	32
f [mm]	70	95	120	95	100	140
g (± 0.2 mm) [mm]	48	65	85	70	70	105
h [mm]	65	85	100	65	85	100
i [mm]	109	142	180	109	158	180
k [mm]	75	99	131	75	115	131
l [mm]	36	50	65	36	50	65
m [mm]	12	5	0	0	0	0
Ø o [mm]	30	40	55	30	40	55
r [mm]	60	81	103	60	81	103
s [mm]	13	17	20	13	17	20
Ø t [mm]	13	17	21	13	17	21
Ø u [mm]	20	26	32	20	26	32
v** (± 0.1) [mm]	22	25	35	22	25	35
x [mm]	52	68	100	52	85	100
y [mm]	27	29	75	27	45	75
Weight [kg]	2.5	6.0	11.0	2.5	6.0	11.0
Part no.						
without position monitoring up to 160 °C*	824035020	824045020	824055020	824035030	824045030	824055030
with position monitoring up to 100 °C	824035120	824045120	824055120	824035130	824045130	824055130

* Higher temperatures up to 300 °C on request, ** clamping edge height As per Euomap Standard on request, tolerance ± 0.1 mm

Accessories

Drill bushes DIN 179	12 x 12	17 x 16	21 x 20	12 x 12	17 x 16	21 x 20
Part no.	3300285	3300287	3300288	3300285	3300287	3300288